

Technical Index

Model	SL-WDPHN-1840-17/19-K
Frequency(GHz)	18~40
Gain(dB)	18(Typical)
VSWR	≤2
Material	Al
Connector	2.92mm-50K
Size(mm)	54*60*122
Surface treatment	Natural conductive oxidation
Paint color	Grey

Outline installation drawing(mm)

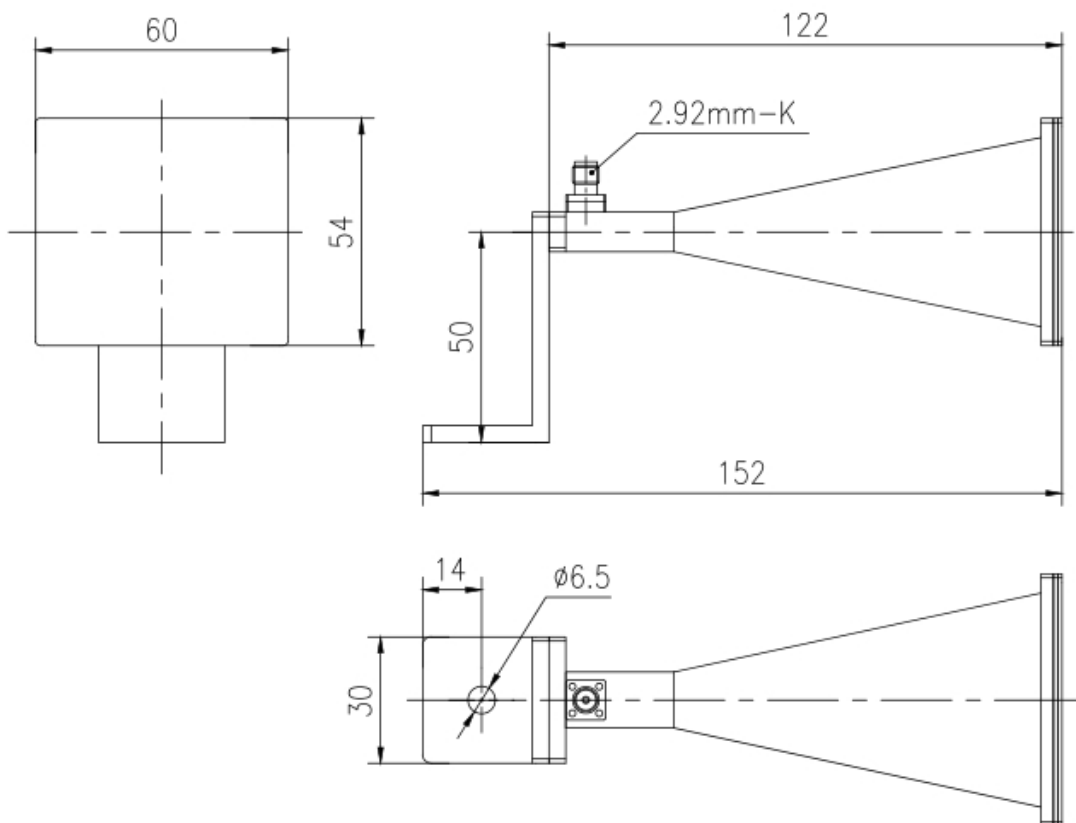

Gain

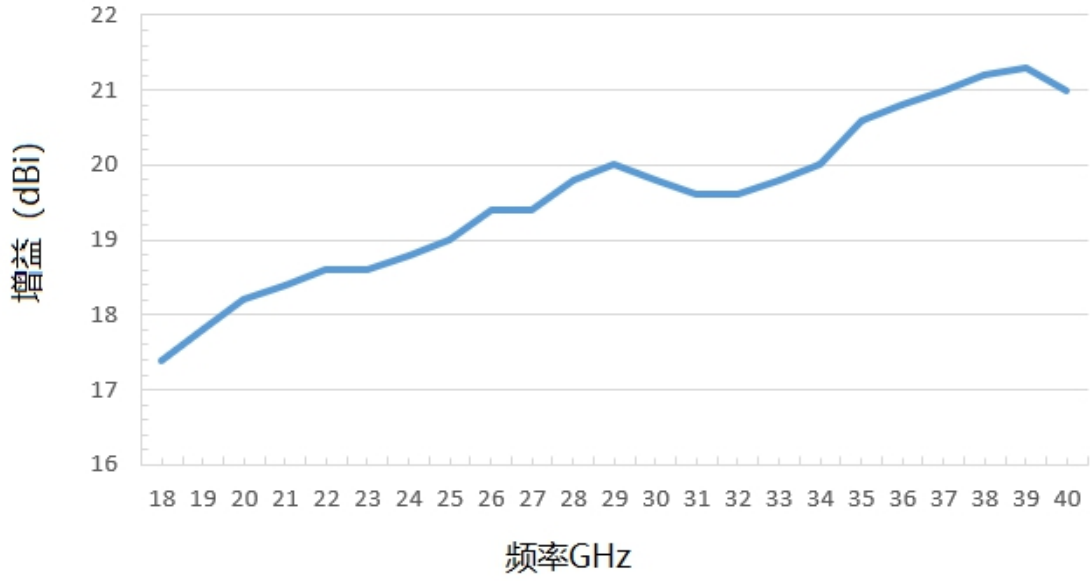

VSWR

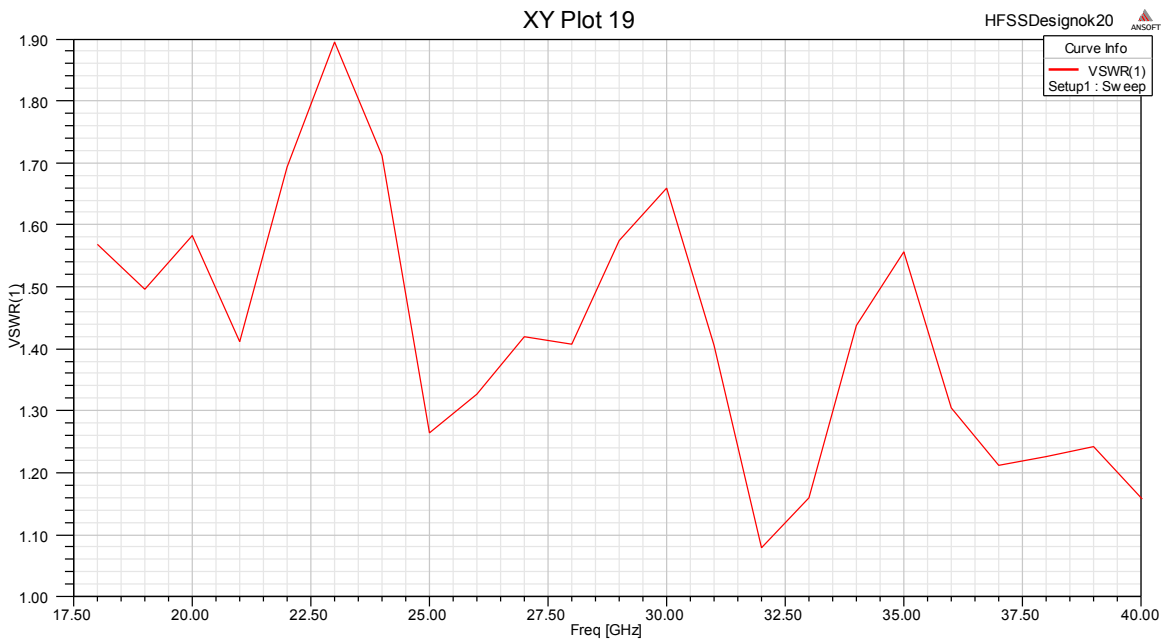

Gain Patterns



Gain@18GHz

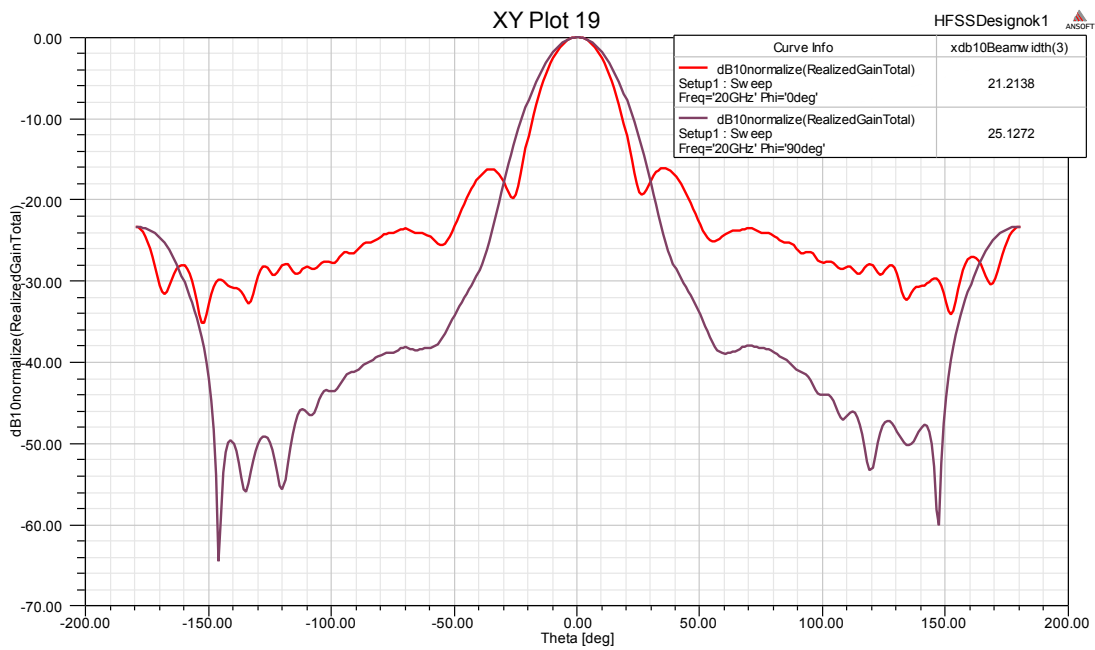

Gain@20GHz

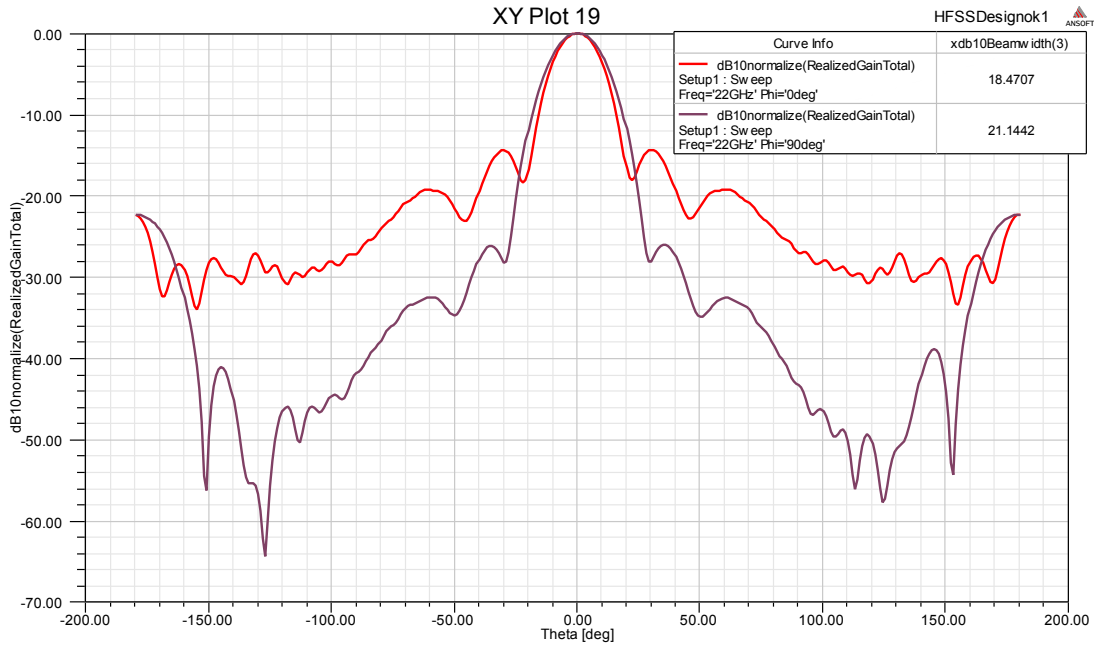

Gain@22GHz

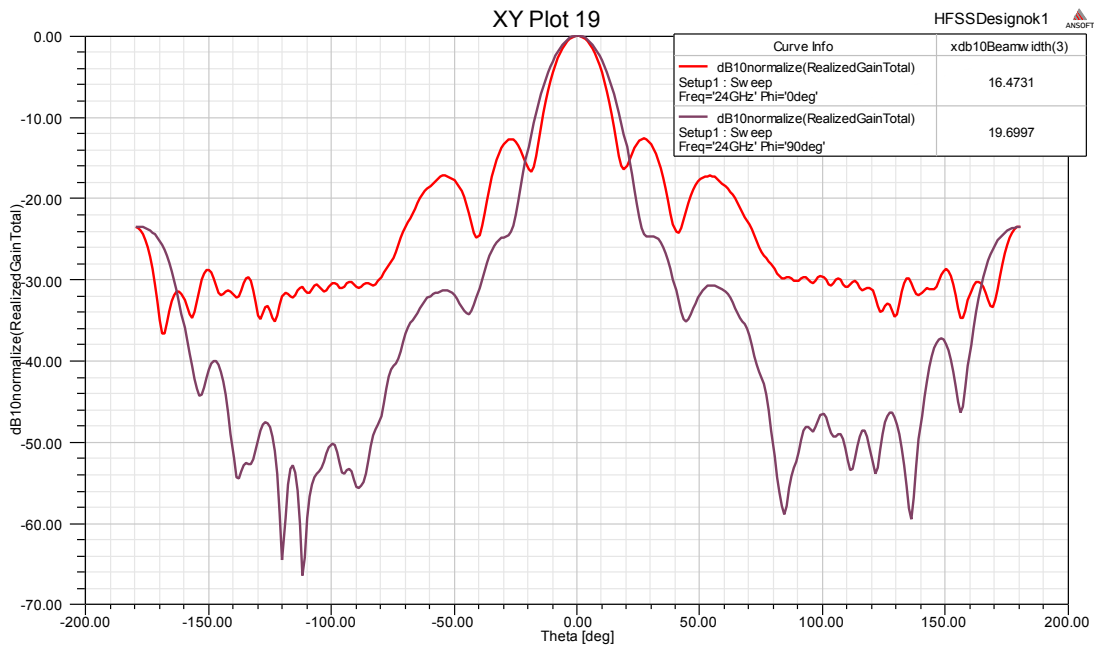

Gain@24GHz

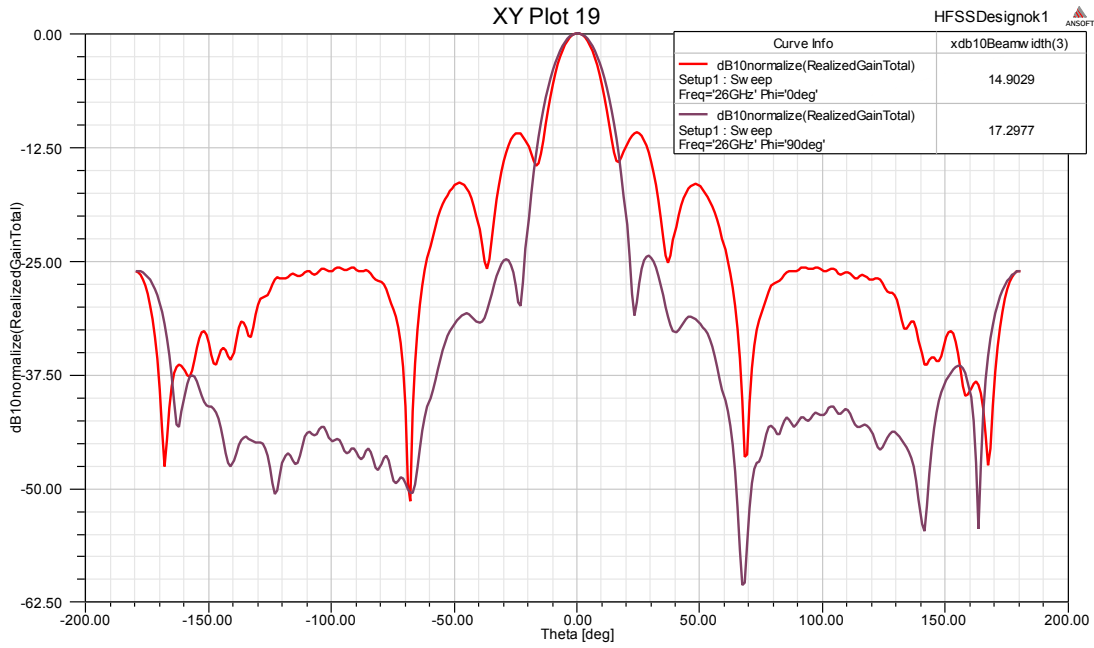

Gain@26GHz

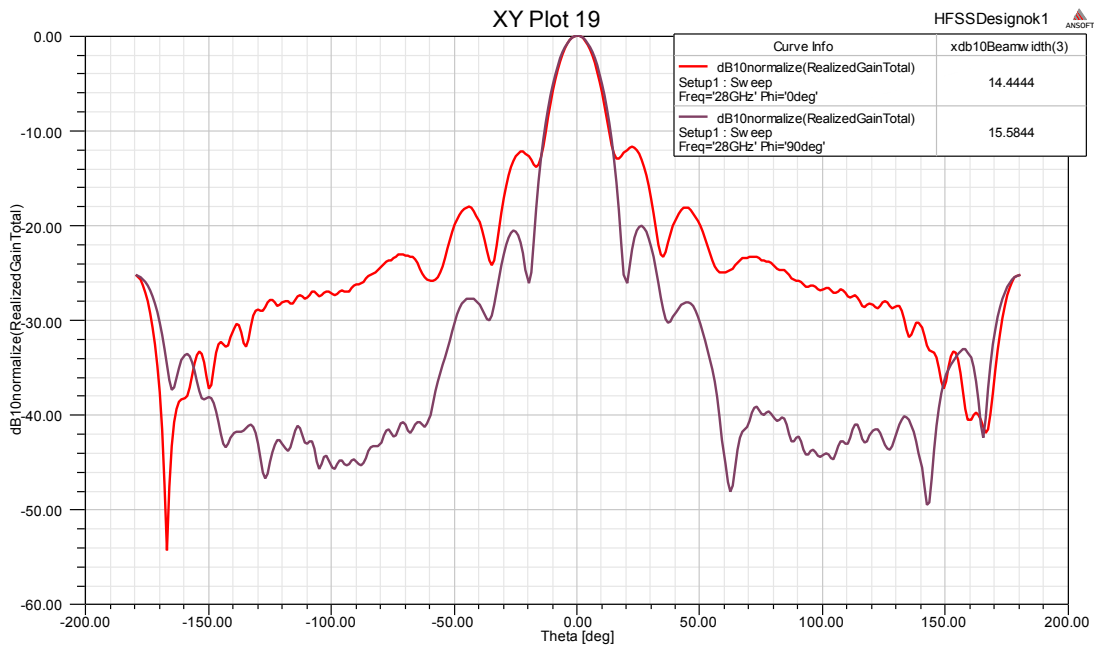

Gain@28GHz

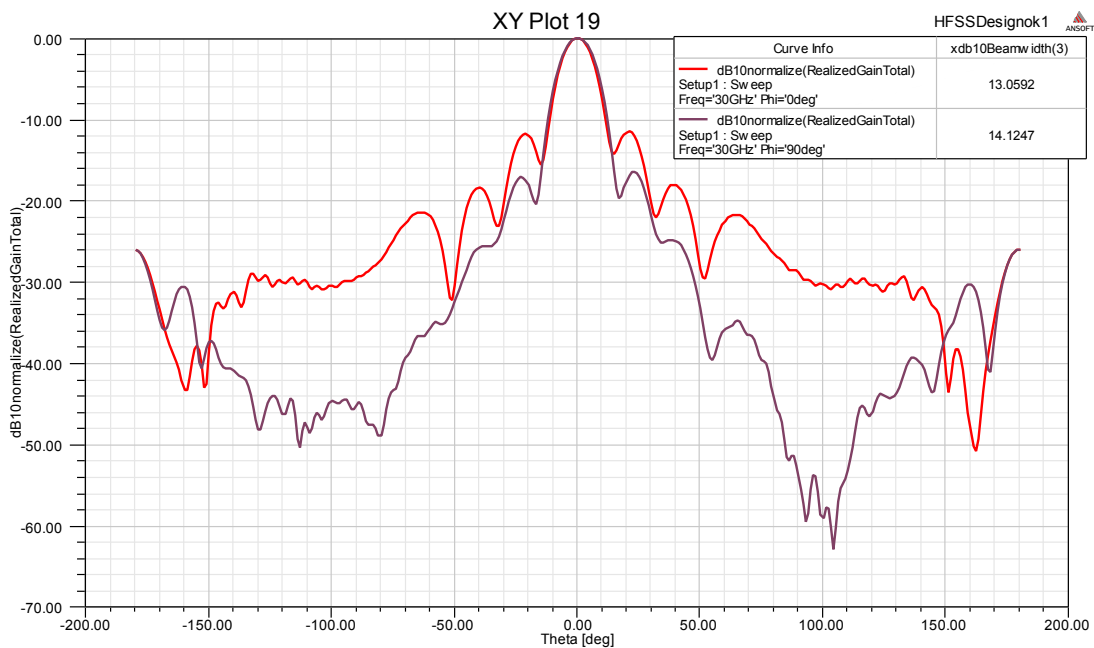

Gain@30GHz

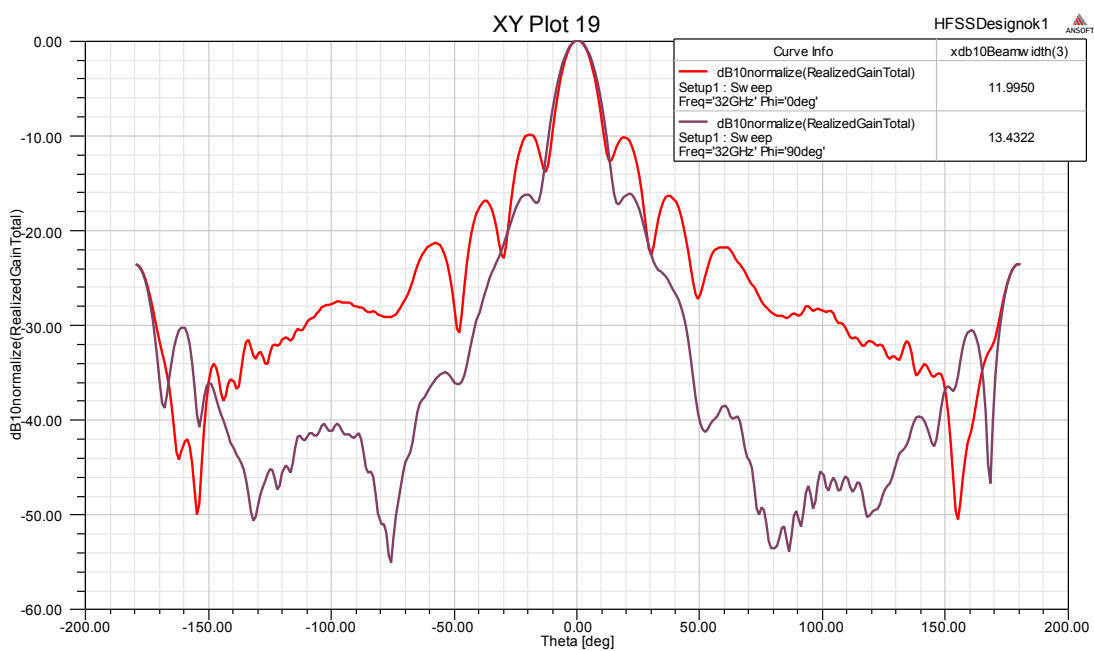

Gain@32GHz

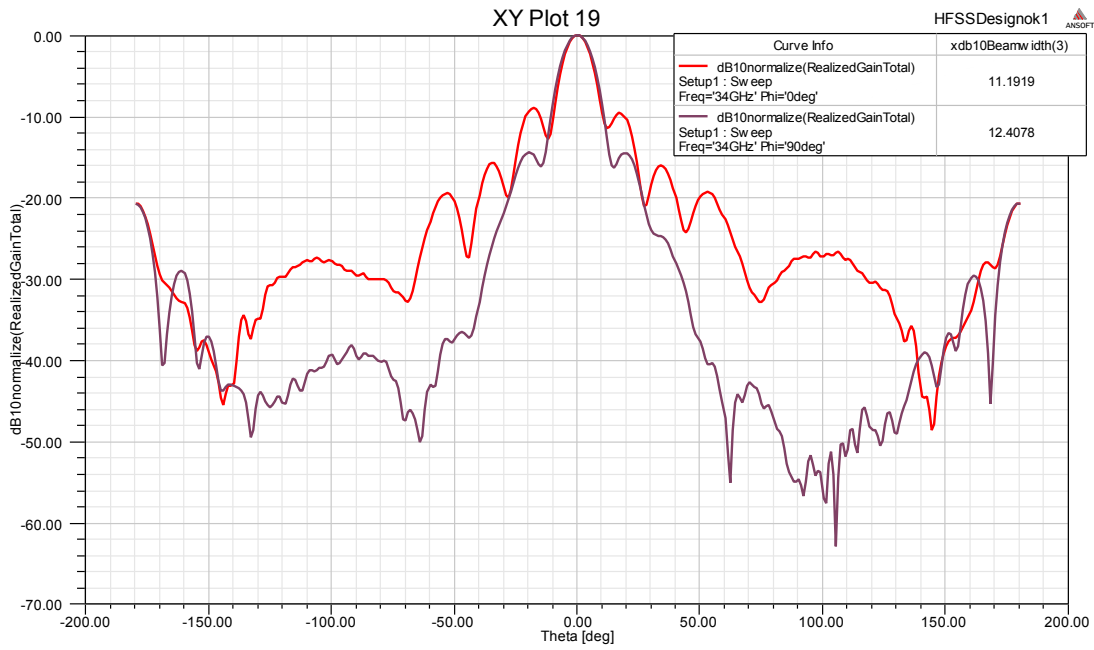

Gain@34GHz

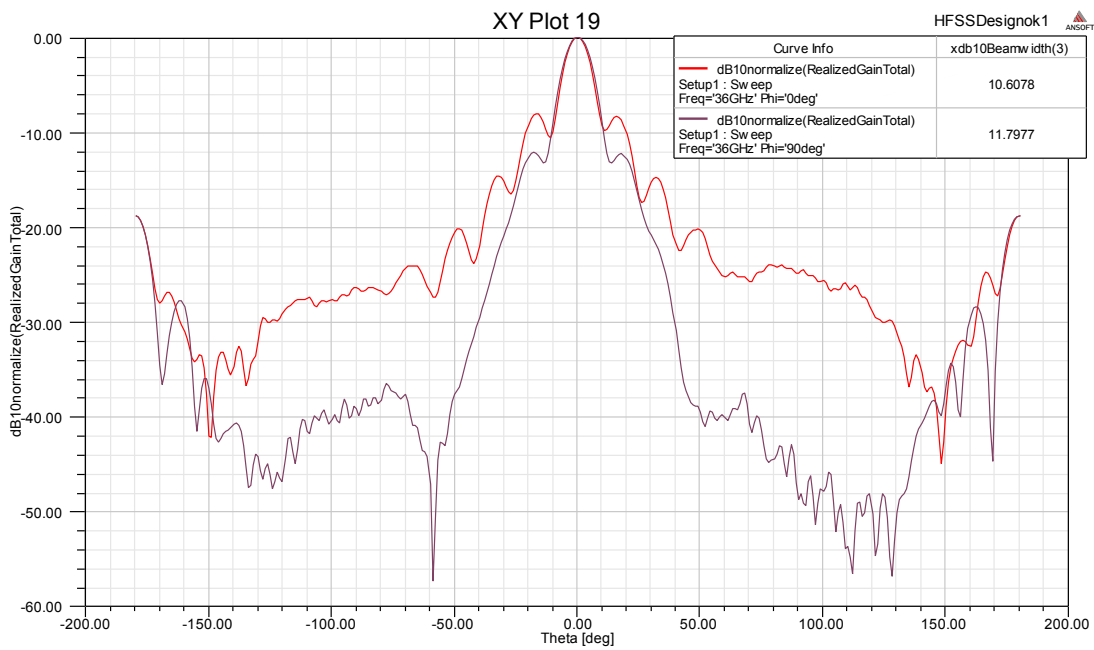

Gain@36GHz

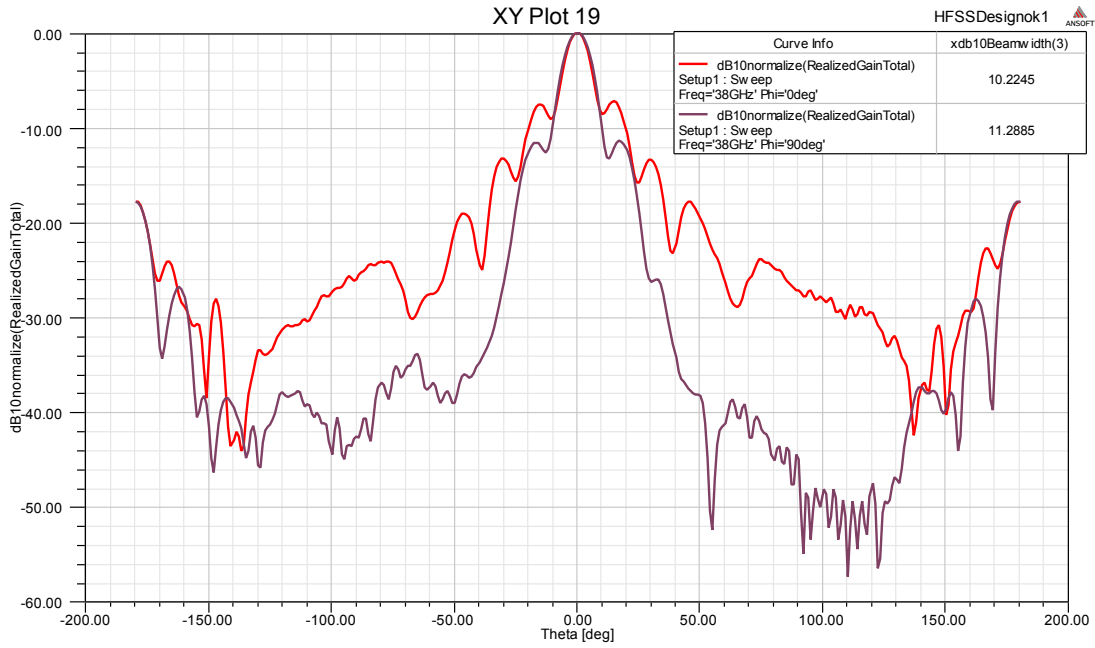

Gain@38GHz

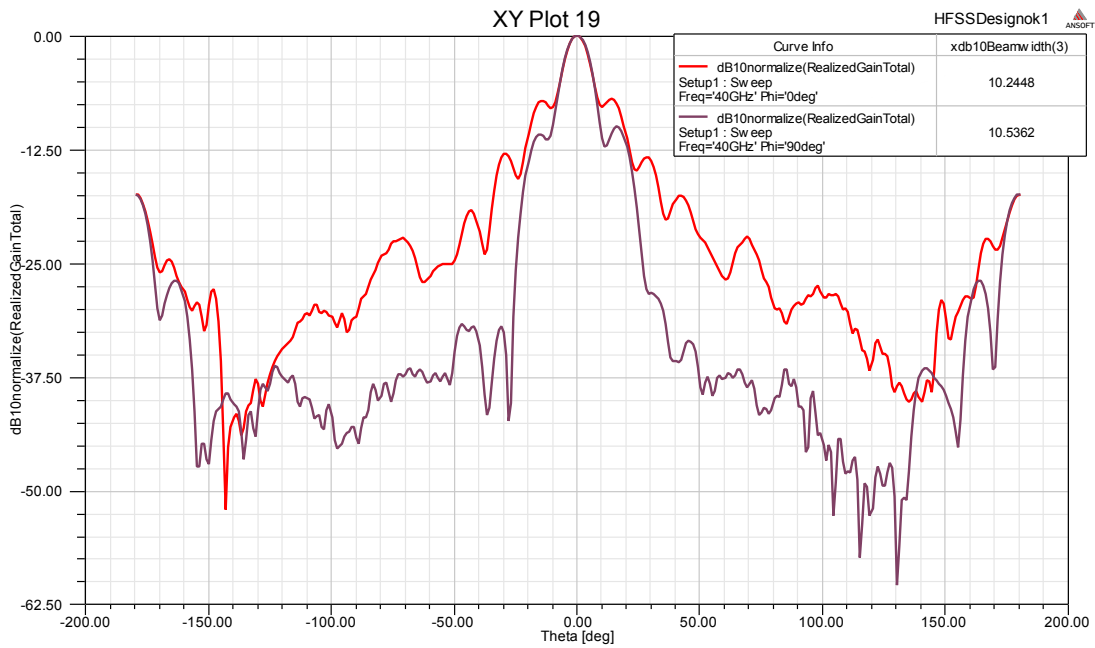

Gain@40GHz